







DEVIreg™ 130, DEVIreg™ 132

DEVIreg™ 130/132 is a line of simple electronic 16 Amps thermostats with possibility to be installed directly on the wall. The thermostats have only one button for adjusting the temperature and for OFF mode. Furthermore, it has an LED indicator showing standby (green light) and heating (red light) periods. The thermostats do not have wire sensor failure monitoring. Wire temperature sensor included in the set.

DEVIreg™ 130 is equipped with a wire (floor) sensor used for control of Comfort Floor Heating applications. The thermostat has a dial for adjusting the temperature setting with a numeric scale from   to 5 (meaning from OFF, 5 °C to 45 °C and each step corresponds to approx. 9 °C). This type of thermostat can be used for outdoor applications too – Ice and Snow Melting on Ground, Frost Protection on Roofs, Pipe Tracing, etc., because it doesn't have wire sensor failure monitoring.

DEVIreg™ 132 is equipped with a built-in air sensor to control the room temperature and an additional floor (wire) sensor to limit the maximum floor temperature. The main application is Total (Direct) Heating via Floor systems. The thermostat has a dial for adjusting the room temperature, with a degree scale from   to 35°C (which means from OFF, 5°C to 35°C). Adjusting maximum floor temperature is provided with potentiometer placed under front cover (default 35°C).

Benefits:



- Low standby consumption
- Installation on the wall
- LED indication
- Frost protection
- Ice and snow melting applications

Standard compliance:

- EN/IEC 60730-1 (general)
- EN/IEC 60730-2-9 (thermostat)

Approvals:



Type	Value
Operation voltage	220 - 240 V, 50/60 Hz
Standby power consumption	Max. 5 W
Resistive load	Max 16 A (3680 W) @ 230 V
Inductive load	Max. 1 A, cos φ = 0,3
Hysteresis	± 0,2°C
Ambient temperature	-10 °C to +30 °C
Frost protection	5 °C - 
Cable specification max	1 x 4 mm ² or 2 x 2,5 mm ²
Ball pressure test temperature	75°C
Pollution degree	2 (domestic use)
Controller type	1 C
Storage temperature	-20 °C to +65 °C
IP class	IP 30
Protection class	Class II - 
Dimensions (H/W/D)	82 x 82 x 36 mm
Weight	90 g

Types

Item no.	Product name	Temp. range	Sensor type	Marking	EAN no.
140F1010	DEVIreg™ 130	5-45 °C	Wire sensor, 3 m, NTC 15 kOhm at 25 °C	D130	5703466208953
140F1011	DEVIreg™ 132	Room: 5-35 °C, max. floor temp.: 20-50 °C (default 35 °C)	Built-in room sensor and wire sensor, 3 m, NTC 15 kOhm at 25 °C	D132	5703466208960

Connection schemes

DEVireg™ 130

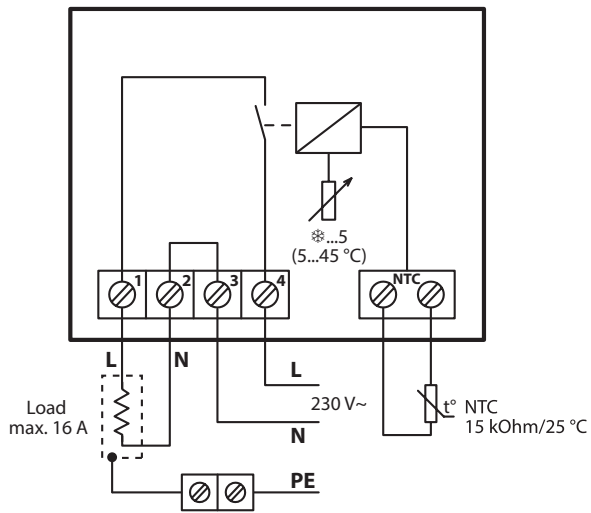

DEVireg™ 132

