

MANIFOLD AND MANIFOLD ACCESSORIES

TECHNICAL DATA

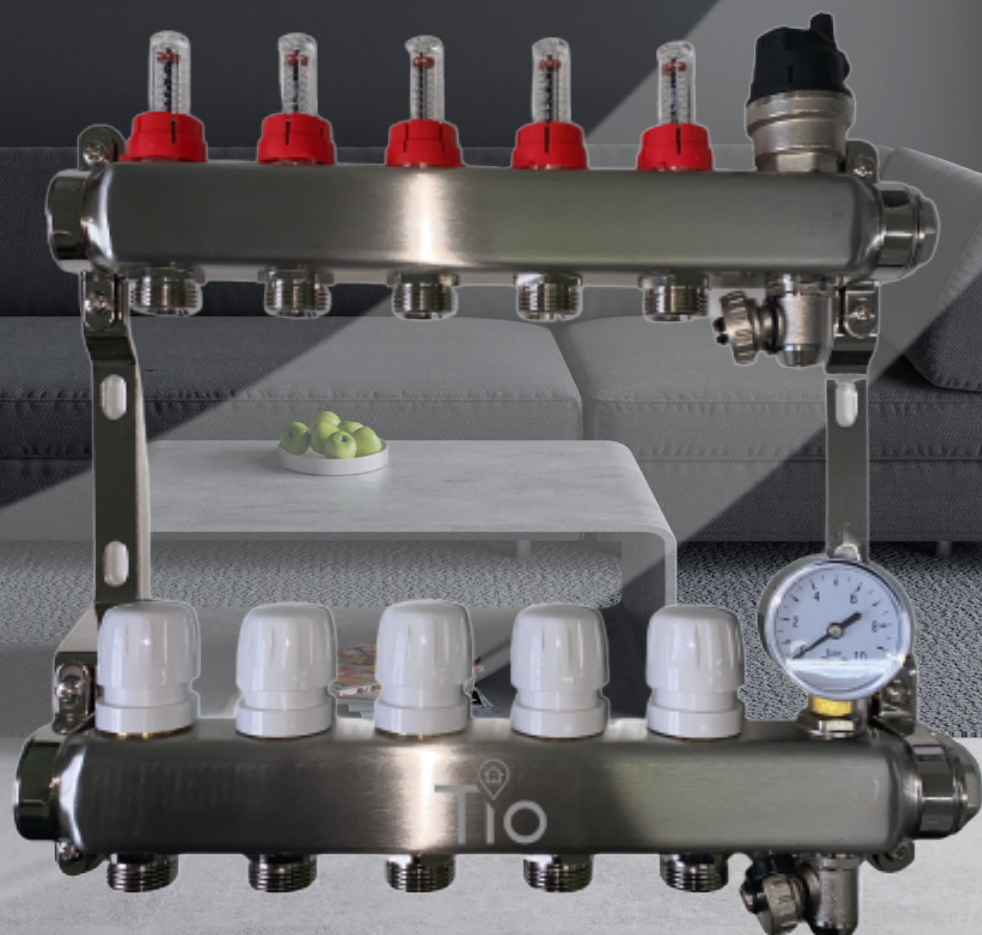

PRODUCTS FOR THE BUILT ENVIRONMENT

**Tio**

www.tioclimatesolutions.co.uk

MANIFOLDS

MANIFOLD WITH PRESSURE GAUGE AND AUTO AIR VENT

The Tio premium stainless-steel manifold is a preassembled unit for use within either underfloor heating systems or with wall hung radiator systems.

KEY FEATURES

- The unit is preassembled, complete with an auto air vent (AAV), 10 bar pressure gauge, flow meters with 0-5 l/m indicators and fill and drain valves.
- Compatible with various pipe sizes up to 20mm.
- Integrated filling and drain off valves ease long term maintenance

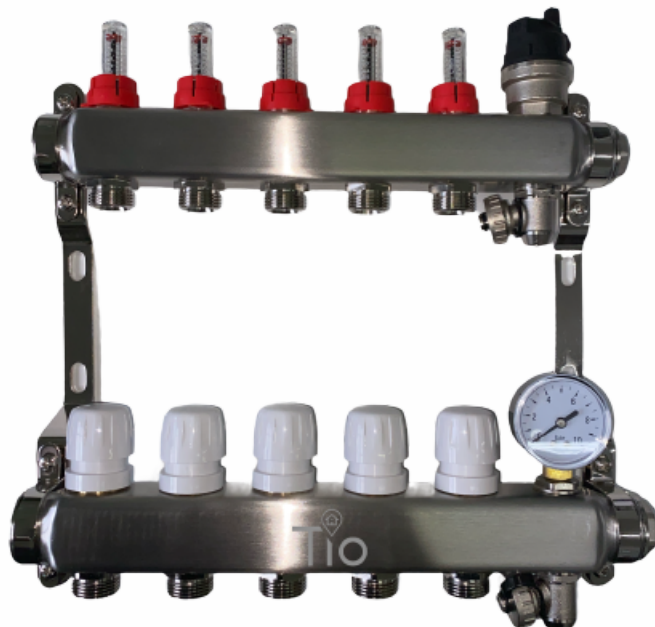

COMPATABLE WITH

ISOLATION VALVES



TIOVAL0001 1" Pair of isolation valves M (1xR/1xB)

TIOVAL0002 1" Pair of isolation valves M (1xR/1xB) with temp gauge

Boxed as a pair, these isolation valves will fit directly onto the manifold mixing unit. We recommend isolation with every system to allow for maintenance in the future. TIOVAL0002 includes a temperature gauge to allow for review of the flow temperature through the corresponding flow or return bar

PIPE CONNECTOR



TIOCON0010 3/4" x 10 x 1.5mm Pipe Connector

TIOCON0012 3/4" x 12 x 2.0mm Pipe Connector

TIOCON0016 3/4" x 16 x 2.0mm Pipe Connector

TIOCON0020 3/4" x 20 x 2.0mm Pipe Connector

3 piece connector to connect pipe to the manifold. Available in 3 sizes. denoted by the outer diameter of the pipe and the and the wall thickness

MANIFOLDS

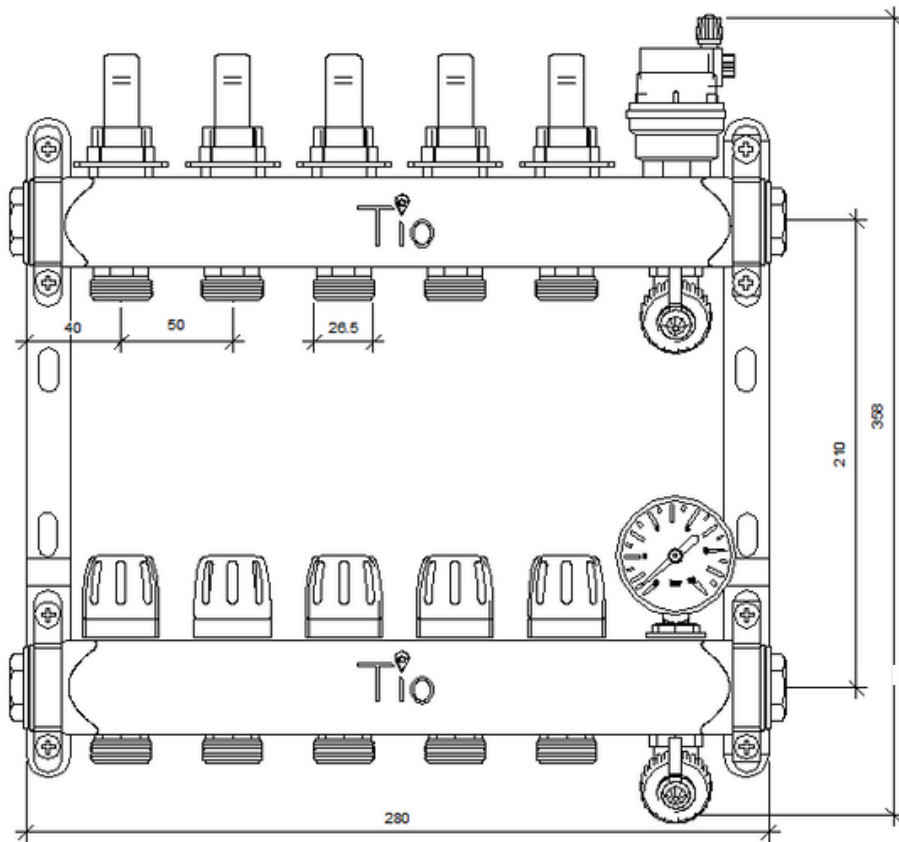

The Tio manifold has a standard UK distance of 210mm between the flow and return bars. This makes the unit versatile with various mixing units. The unit has spacing of 50mm between each port from the centre point. This enables various pipe sizes and materials to be installed. For ease of installation we recommend no larger than 20mm pipe to be installed with the Tio manifold connectors. The unit has 1" threaded inlets to house isolation valves. We recommend when installing with the TIOMIX0003 mixing unit that a captive universal nut be used for fixing. The bottom rail has a modulating pin that can be either manually adjust with the white adjusting caps, or to achieve electronic control an actuator can be installed.

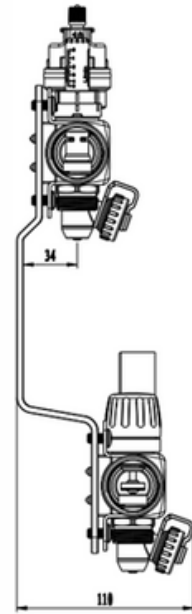

The Tio premium stainless steel manifold can be wall mounted by using the brackets provided. Suitable wall fixings will need to be assessed. =All componentry is supplied within the box unit.

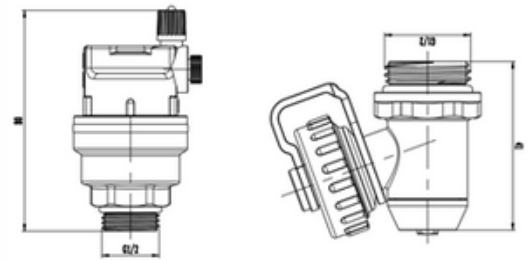

The Tio componentry included an automatic air vent with a 1/2 inch inlet and a drain/fill valve with a 1/2 inch inlet.

PRODUCT CODE	LENGTH	DESCRIPTION
TIOMAN0002	180mm	2 Port Manifold with PG and AAV
TIOMAN0003	230mm	3 Port Manifold with PG and AAV
TIOMAN0004	280mm	4 Port Manifold with PG and AAV
TIOMAN0005	330mm	5 Port Manifold with PG and AAV
TIOMAN0006	380mm	6 Port Manifold with PG and AAV
TIOMAN0007	430mm	7 Port Manifold with PG and AAV
TIOMAN0008	480mm	8 Port Manifold with PG and AAV
TIOMAN0009	530mm	9 Port Manifold with PG and AAV
TIOMAN00010	580mm	10 Port Manifold with PG and AAV
TIOMAN00011	630mm	11 Port Manifold with PG and AAV
TIOMAN00012	680mm	12 Port Manifold with PG and AAV

MANIFOLD COMMISSIONING INFORMATION

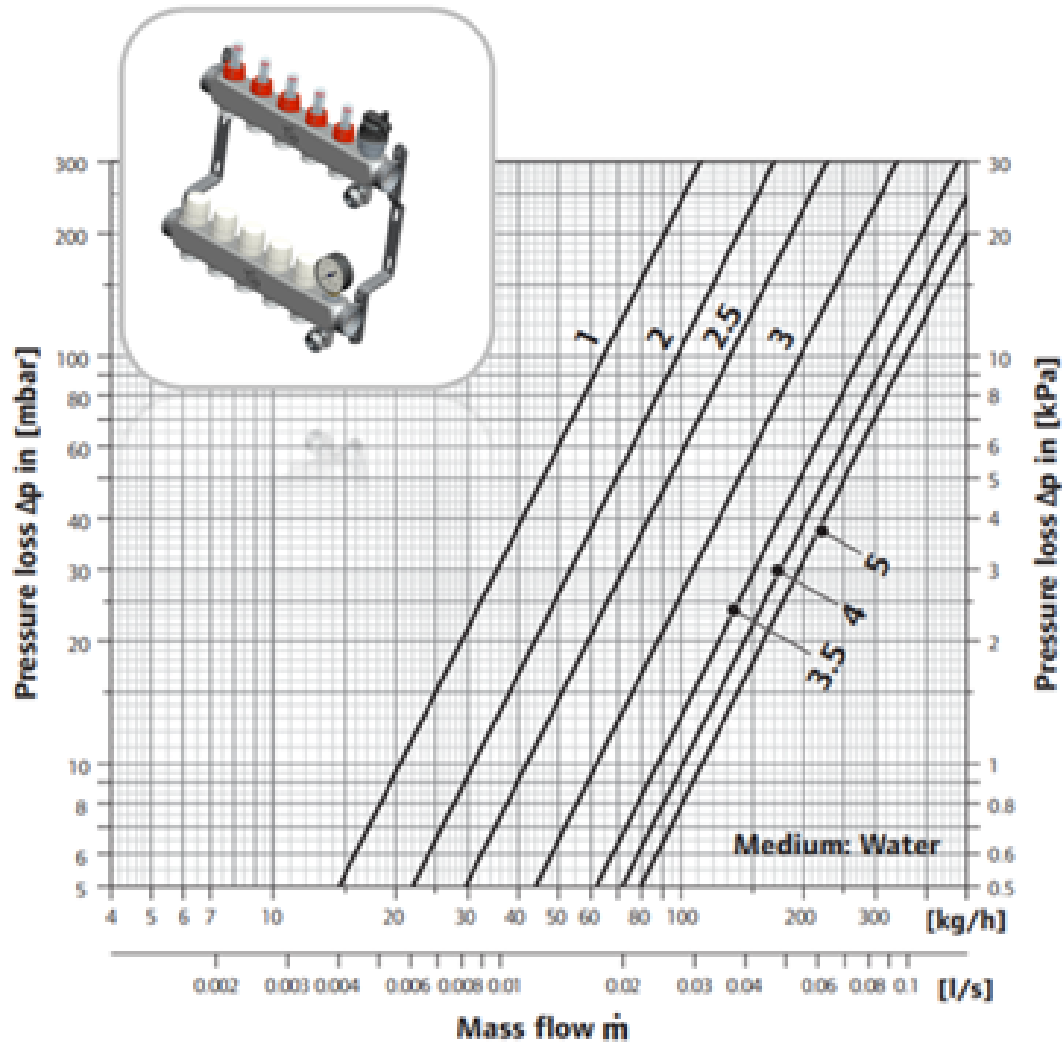

Flow and pressure loss in [mbar] and associated correlating [kPa] is indicated in the attached chart. The unit has the ability to adjust flow in accordance with professionally design project criteria. The flow meter is adjusted using the anti-clockwise and clockwise trunch mechanism to open and close the port and increase and reduce flow respectively.



MANIFOLD COMMISSIONING INFORMATION

Filling

We recommend filling each circuit separately, opening the return isolation valves and double regulating valves each time and closing them again when the circuit is full as per the instructions below:

Isolate the manifold via the ball valves.

2. Connect a hose to the return manifold (the bottom manifold bar) via the drain point. The discharge hose should be run to a bucket or drain age point.

3 Connect mains pressure water to the flow manifold (the top manifold bar) via the fill point.

Close all of the return valves by turning the blue adjustable heads clockwise.

Open Flowmeter valve and the corresponding return isolation valves. Begin filling the first circuit.

Once the water flowing from the discharge hose is flowing smoothly all air has been removed from the circuit.

Close this circuit and fill the next circuit following the same procedure

Testing

1. Once filled, the system should be pressure tested in accordance with EN1264-4:2009 between 4-6bar.

2. The system should be left under pressure whilst fixing a floor or laying the screed.

Commissioning

1. In order to commission the system the heat source needs to be operating to deliver the required temperature water to the manifold and the primary and secondary pumps need to be operating.

2. To adjust the flow meters, follow the adjustment procedure above. The actual required flow will depend on the heat requirement of the room and the amount of pipe in the floor. Most modern buildings insulated to current building regulations will require around 50- 60W/m². As a general guide, we recommend that the following flow rates are set (when using 16mm pipe at 200mm centres):

3. Replace the red locking ring once the flow meters are set.

4. The underfloor heating pipework will not corrode in any way since it's plastic, however, it is recommended that a suitable inhibitor is added to avoid the corrosion of primary pipework, the heat source and any other towel rails or radiators on the system.

5. Initial setting of the thermostatic blending valve (after the initial system start-up/screed drying period) should provide the following temperatures: - Screeded/dry screed board floors: 35-45°C - Timber/floating floors: 45-55°C

Depending on Design

System Start Up

For screed floors, ensure a minimum of 21 days have elapsed since laying the concrete screed, or seven days if an anhydrite floor screed is utilised. Wooden floors can be switched on quite early, but should not be allowed to reach too high a temperature too soon.

Wood being a natural material requires that both the floor and deck and joists must be treated with care until temperature and humidity have stabilised. Where water temperature controls are utilised, ensure they are set the minimum setting (typically 25-30oC) and that room thermostats and flow meters are set to design condition, as this will aid gradual drying of the floor and structure.

System responses will be very slow on initial start-up. After the heating has been running for the recommended time at minimum setting (3 days for solid concrete floors and 1 day for wooden suspended floors), gradually raise the water temperature to the design setting for a further 4 days.

Once running normally there should be a 7-8oC temperature drop across the circuits. Once all action are complete, turn down all thermostats so that the system stops. Now turn up one thermostat and ensure the correct actuator or actuators have opened for that particular room. After its determined that the thermostat is controlling the correct actuator, turn the thermostat down and repeat the procedure.

LOW LOSS HEADER

TIOLLH0001

1 inch male threaded inlets

Integral drain valve

Automatic Air Vent

Insulating Sheath

Size : 1899 (ml)

Flow Rate : 6600 L/h

Hydraulic Headers are connected before the Distribution Header and hydraulically isolates the primary and secondary circuits; this allows the primary flow to be maintained at boiler manufacturer's requirements and provides greater volumetric flow in the Distribution Header to all circuits.

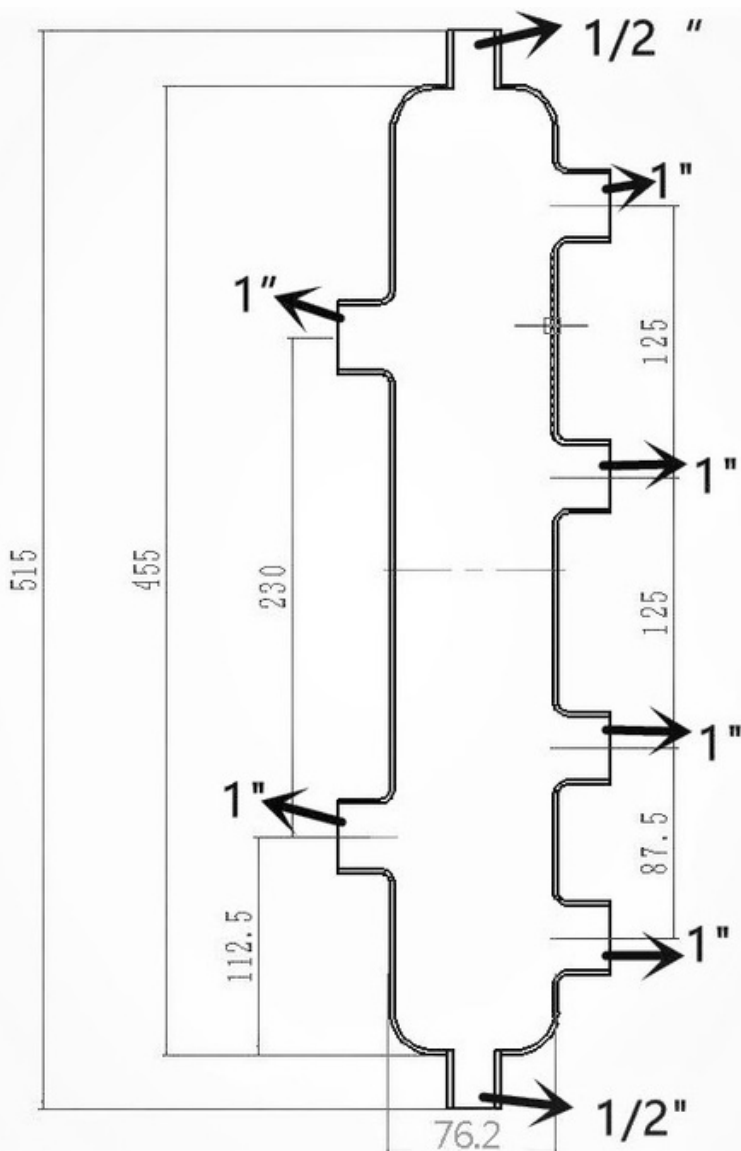

MANIFOLD CABINETS

OVERPLASTER CABINET

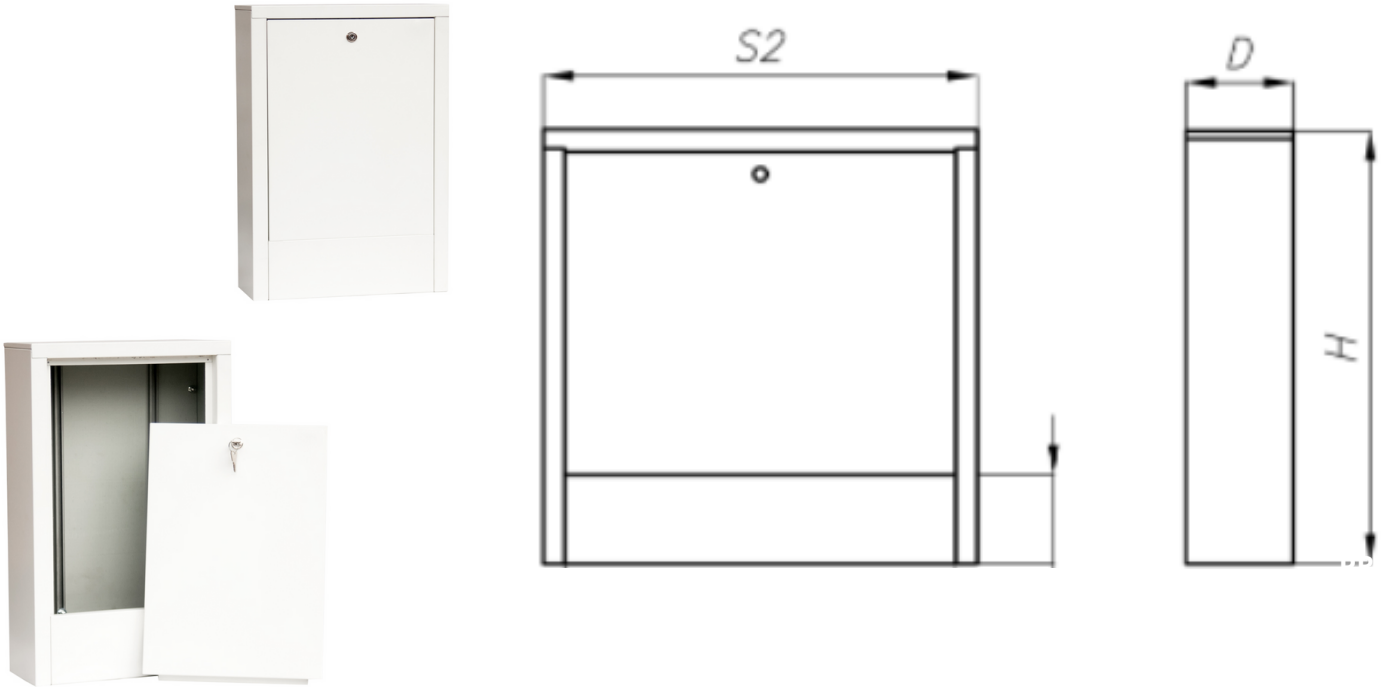

Code	S2 (mm)	H (mm)	D (mm)	weight (kg)	Quantity	Gross weight (kg)
TIOCAB0002	760	585	120	9.3	1	10.8
TIOCAB0003	845	585	120	10	1	11.5
TIOCAB0004	1015	585	120	10.8	1	11.6

KEY FEATURES

Cabinets are used for water and heating manifold, as well as underfloor heating mixing units.

- The back wall equipped with rails and bolts for mounting manifold
- Side walls with holes for the supply and return pipe of heating medium
- Feet used for mounting cabinets to the floor
- Screws for fixing the manifold
- Removable front door
- Adjustable height and depth
- Cabinet doors with a lock and key as standard



TIO Climate Solutions
c/o H&H Distribution
Unit X&Y
The Steventon Depot
Hanney Road
OX13 6DJ



www.tioclimatesolutions.co.uk
01235 242710
office@tioclimatesolutions.co.uk