

TIO STAT

PROGRAMMABLE INSTRUCTIONS



AVAILABLE IN WHITE & BLACK



MODELS: TIOSTAT , TIO E, TIOSMART



MODELS: TIOSTAT, TIOSMART

CONTENTS

PAGE 4

PROGRAMMABLE THERMOSTAT EXPLANATION

PAGE 5

INSTALLATION

PAGE 6

LCD DISPLAY

PAGE 7

DAY/TIME SETTINGS

PAGE 8

MANUAL MODE

PAGE 9

PROGRAMMABLE MODE

PAGE 10

PROGRAMMABLE SETTINGS

PAGE 11

PRE-SET TIME & TEMP ZONES

PAGE 12

HOLIDAY MODE

PAGE 13

CHILD LOCK

PAGE 14

FACTORY RE-SET

PAGE 15

CONFIGURATION SETTINGS

PAGE 16

WIRING CENTRE

PAGE 17

TIO SMART APP

PAGE 18

HOW TO USE APP

PAGE 19

SMART APP FEATURES



PROGRAMMABLE THERMOSTAT

A programmable thermostat is a thermostat with the ability to adjust home heating equipment according to a pre-set schedule. For instance, a programmable thermostat could be set to maintain a home temperature of 16°C throughout the day, and 22°C degrees from 10:00 p.m. to 6:00 a.m. every night.

A room thermostat works by sensing the air temperature, switching on the heating when the air temperature falls below the thermostat setting, and switching it off once this set temperature has been reached.

The Tio Stat allows you to choose what times you want the heating to be on, and what temperature it should reach while it is on.

Your thermostat need a free flow of air to sense the temperature, so they must not be covered by curtains or blocked by furniture. Nearby electric fires, televisions, wall or table lamps may also prevent the thermostat from working properly.

Time Display	Weekday (MON-FRI)		Weekend (Saturday)		Weekend (Sunday)	
	TIME	SET TEMP	TIME	SET TEMP	TIME	SET TEMP
PERIOD 1 	06:00	22°C	06:00	22°C	06:00	22°C
PERIOD 2 	08:00	16°C	08:00	16°C	08:00	16°C
PERIOD 3 	12:00	22°C	12:00	22°C	12:00	22°C
PERIOD 4 	14:00	16°C	14:00	16°C	14:00	16°C
PERIOD 5 	18:00	22°C	18:00	22°C	18:00	22°C
PERIOD 6 	22:00	16°C	22:00	16°C	22:00	16°C



Setting a programmable room thermostat to a higher temperature will not make the room heat up any faster. How quickly the room heats up depends on the design and size of the heating system. Similarly reducing the temperature setting does not affect how quickly the room cools down.

Your thermostat is suitable for installation within a standard 86mm pattress box or European 60mm round pattress box.

1. Keep power off. Remove the mounting Plate.

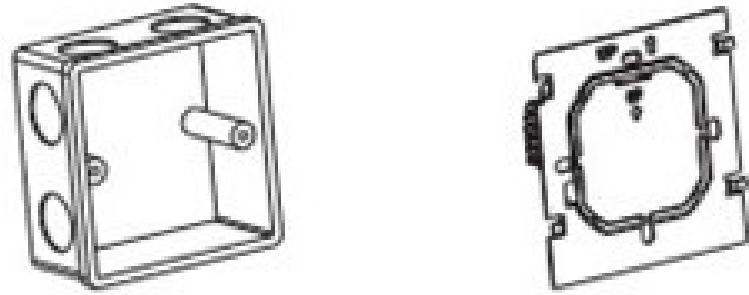

2. Connect power supply, load and external (floor) sensor into the appropriate terminals if there is external sensor. (see "Wiring your thermostat" for details and Fix the mounting plate into the wall with screws in the box.

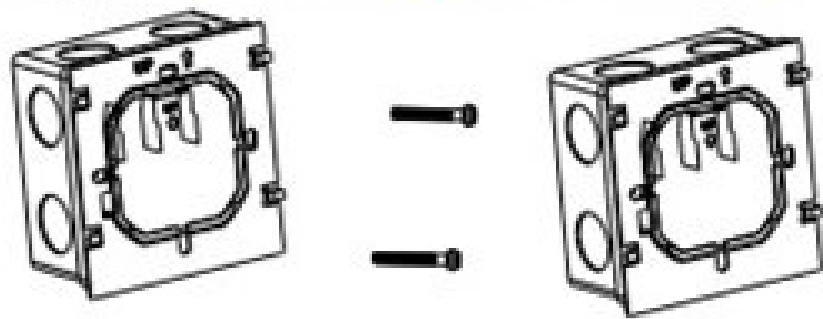

3. Fasten body of thermostat and the mounting plate through the groove. Installation complete.

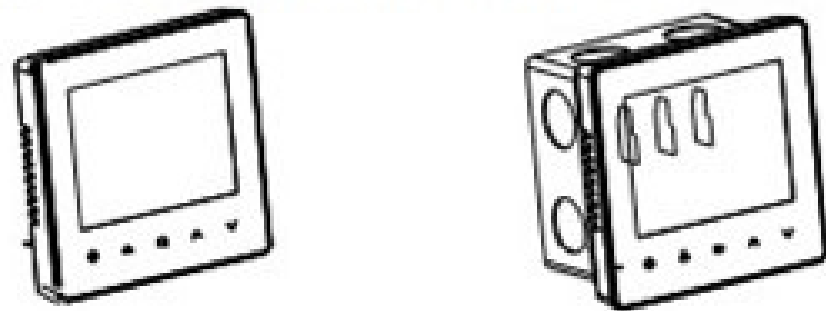

RISK OF ELECTRICAL SHOCK. Disconnect/isolate power supply prior to making electrical connections. Contact with high voltage components can cause electrical shock, severe injury or death.

INSTALLATION



Do

Mount the thermostat at eye level.

Read the instructions fully so you get the best from our product.



Don't

Do not install near to a direct heat source as this will affect functionality.

Do not push hard on the LCD screen as this may cause irreparable damage.

Step 1:

Remove the screen from the bottom face of the thermostat by sliding the screen up out of the grooves. then carefully separate the front half from the back plate by unclipping the wire plug.

Step 2:

Place the thermostat screen somewhere safe.

Step 3:

Screw the thermostat back plate securely into the back box.

Step 4:

Clip the front of the thermostat onto the back plate.

 **POWER**

 **TIME**

 **UP**

 **DOWN**

 **MENU**

 **MANUAL**

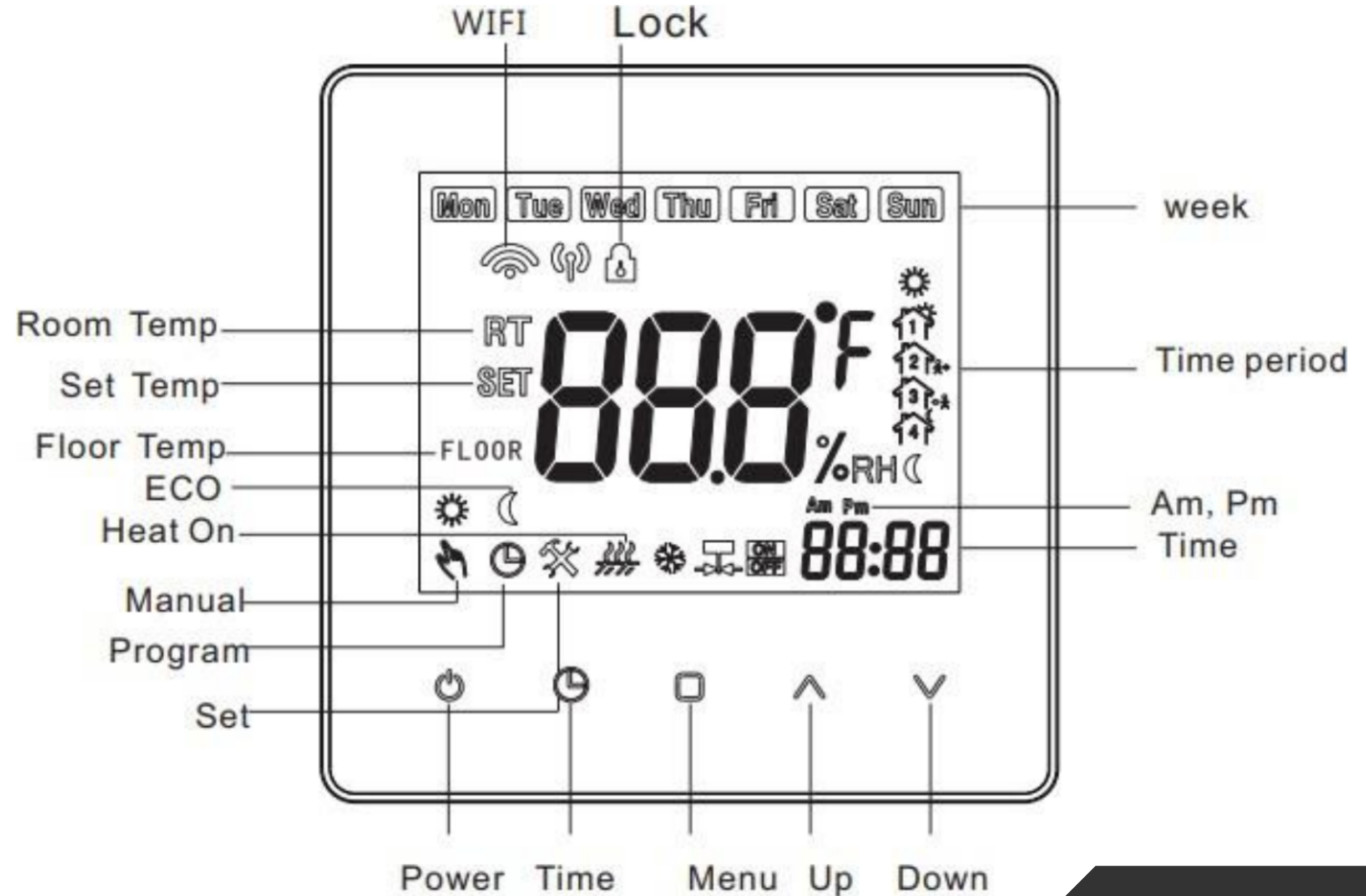

DAY/TIME SETTINGS

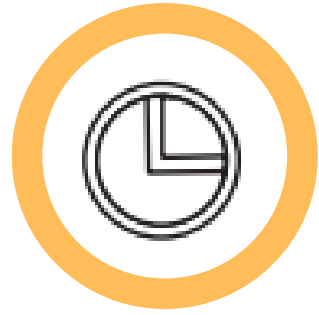

Set Time/ Day:

Press  to set Time and Day of Week

Press once to set minute

Press Twice to set Hour

Press Three times to set Day of the week

Press  to save and return to Home Screen



MINUTE - HOUR - DAY

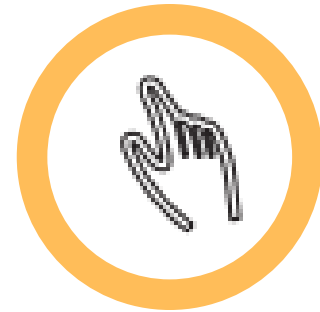

When you are adjusting any setting, pressing  will save what you have done and return you to the home screen



Manual Mode:

Press  to select  manual mode. When you are on program mode  will show in bottom left corner.

Simple press   to select desired temperature

Remember: Setting a programmable room thermostat to a higher temperature will not make the room heat up any faster



The way to set and use your programmable room thermostat is to find the lowest temperature settings that you are comfortable with at the different times you have chosen, and then leave it alone to do its job. The best way to do this is to set the room thermostat to a low temperature, and then turn it up by 1°C each day until you are comfortable. You won't have to adjust the thermostat further. Any adjustment above this setting will waste energy and cost you more money.

PROGRAMMABLE MODE

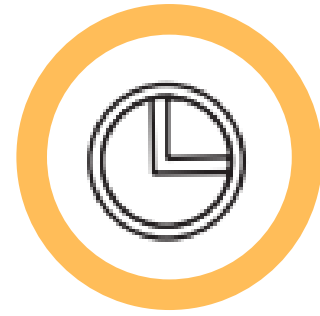

Programmable Mode:



Press  to select  programmable mode.  will show in bottom left corner.

Press  for 7 seconds to activate program set mode.

Press  to set the desired (5+1+1) six periods time and temp, using   to select time and temp

When you have set your time and temp period press  to save and return to home screen.

Temporary Mode:

During program mode. If you need to change the temp. icons   will appear. The pre- program setting will return in the next period.

PROGRAMMABLE SETTINGS

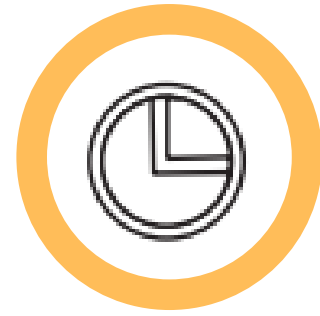

Program Mode:

When power is on, press  for 7 seconds to enter programmable mode. Press  to change the different items. Press   to set the relative values.

The order

Mon - Fri

Period Time → Period Temp, for 6 time periods (page 11)

Sat

Period Time → Period Temp, for 6 time periods (page 11)

Sun







Period Time → Period Temp, for 6 time periods (page 11)

("Mon-Fri", "Sat", "Sun", is "5+1+1" Every , every zones and a time temperature setting)



It is faster to program the same schedule for the entire week and then to adjust the exceptional days

PRE-SET TIME & TEMP ZONES

Time Display	Weekday (MON-FRI)		Weekend (Saturday)		Weekend (Sunday)	
	TIME	SET TEMP	TIME	SET TEMP	TIME	SET TEMP
PERIOD 1 	06:00	22°C	06:00	22°C	06:00	22°C
PERIOD 2 	08:00	16°C	08:00	16°C	08:00	16°C
PERIOD 3 	12:00	22°C	12:00	22°C	12:00	22°C
PERIOD 4 	14:00	16°C	14:00	16°C	14:00	16°C
PERIOD 5 	18:00	22°C	18:00	22°C	18:00	22°C
PERIOD 6 	22:00	16°C	22:00	16°C	22:00	16°C



HOLIDAY MODE



Holiday Mode

Press  for seven seconds to enter Holiday mode. The  will appear in bottom left corner

Press  to select and set desired temperature, using  

Press  to select days. Use   to change day range 0-99

Press  to set Holiday mode and return to home screen

Press  to exit Holiday Mode



Your Thermostat will return to its pre-set programme settings, once you exit Holiday mode:



CHILD/SAFETY LOCK

Press   for 7 seconds to activate safety lock

To Deactivate safety lock

Press   for 7 seconds to deactivate safety lock

CHILD SAFETY LOCK



FACTORY RE-SET

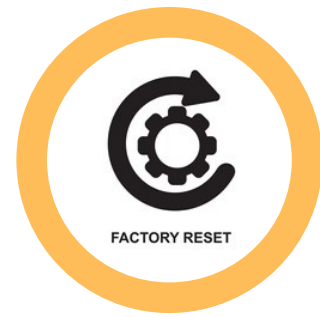

PROGRAM RE-SET

Make sure thermostat is **ON**

Press  for seven seconds to enter program mode

Press   together for seven seconds to go to Factory Settings

The LCD will display 'def' in the bottom right corner.

Allow to 'def' to stop flashing and return to home screen.

CONFIGURATION RE-SET

Make sure thermostat is **OFF**

Press  for seven seconds to enter Configuration Menu

Press   together for seven seconds to go to Factory Settings

The LCD will display 'def' in the bottom right corner,.

Allow to 'def' to stop flashing and return to home screen by pressing 



FACTORY RESET

No.	FUNCTION	PRESS   TO SET	DEFAULT
1	CALIBRATION To adjust to actual temperature if needed	-9°C to 9°C	0°C
2	DEAD ZONE (DEADBAND) To prevent heating system cycling on and off	0.5°C to 5°C	1°C
3	LOCK	0 – ALL BUTTONS WILL LOCK EXCEPT POWER BUTTON 1 – ALL BUTTONS WILL LOCK	0
4	SENSOR SELECTION	IN: = Control temperature using the internal sensor OU: = Control temperature using external sensor ALL: = Both inner and external sensor	All
5	MINIMUM TEMPERATURE SETTING	5°C to 20°C	5°C
6	MAXIMUM TEMPERATURE SETTING	20°C to 35°C	35°C
7	DISPLAY MODE To be displayed on LCD	0 – Room Temperature 1 – Setting Temperature	0
8	STANDBY BACKLIGHT	0-100	10
9	HIGH TEMPERATURE PROTECTION (EXTERNAL SENSORS ONLY)	25°C to 70°C	45°C
A	ANTI-FREEZE TEMPERATURE RANGE	2 TO 10°C	5°C
B	LOW TEMPERATURE PROTECTION (ANTI-FREEZE PROTECTION)	0 – OFF 1 – ON.	0
C	ECO MODE It'll only kick your heat on when the temperature in your home goes below the Eco Temperature	0 – OFF 1 – ON	0
D	ECO TEMP SET RANGE	5°C to 30°C	16°C
E	BACKLIGHT SELECTION	1-100	80

CONFIGURATION MENU

Make sure thermostat is **OFF**

Press  for seven seconds to enter Configuration Menu

Once in the menu

Press  to change parameters

Press  to confirm the setting

WIRING CENTRE

TIOWIR0001

230V – 8 Zone Wiring Control Centre



A 230V 8 zone wiring centre with zonal LED indicators and independent boiler/pump interlock for use with underfloor heating systems.

Power	240V AC 50/60Hz
Operating temperature	-20 – 60°C
Relay output max	3A
Colour/Material	White ABS
Dimensions	240 x 110 x 42mm
No. of Zones	8
Pump Delay adjustment	0.5 - 2 mins
Reset Button	Internal
Fuse rating	3A
IP rating	20

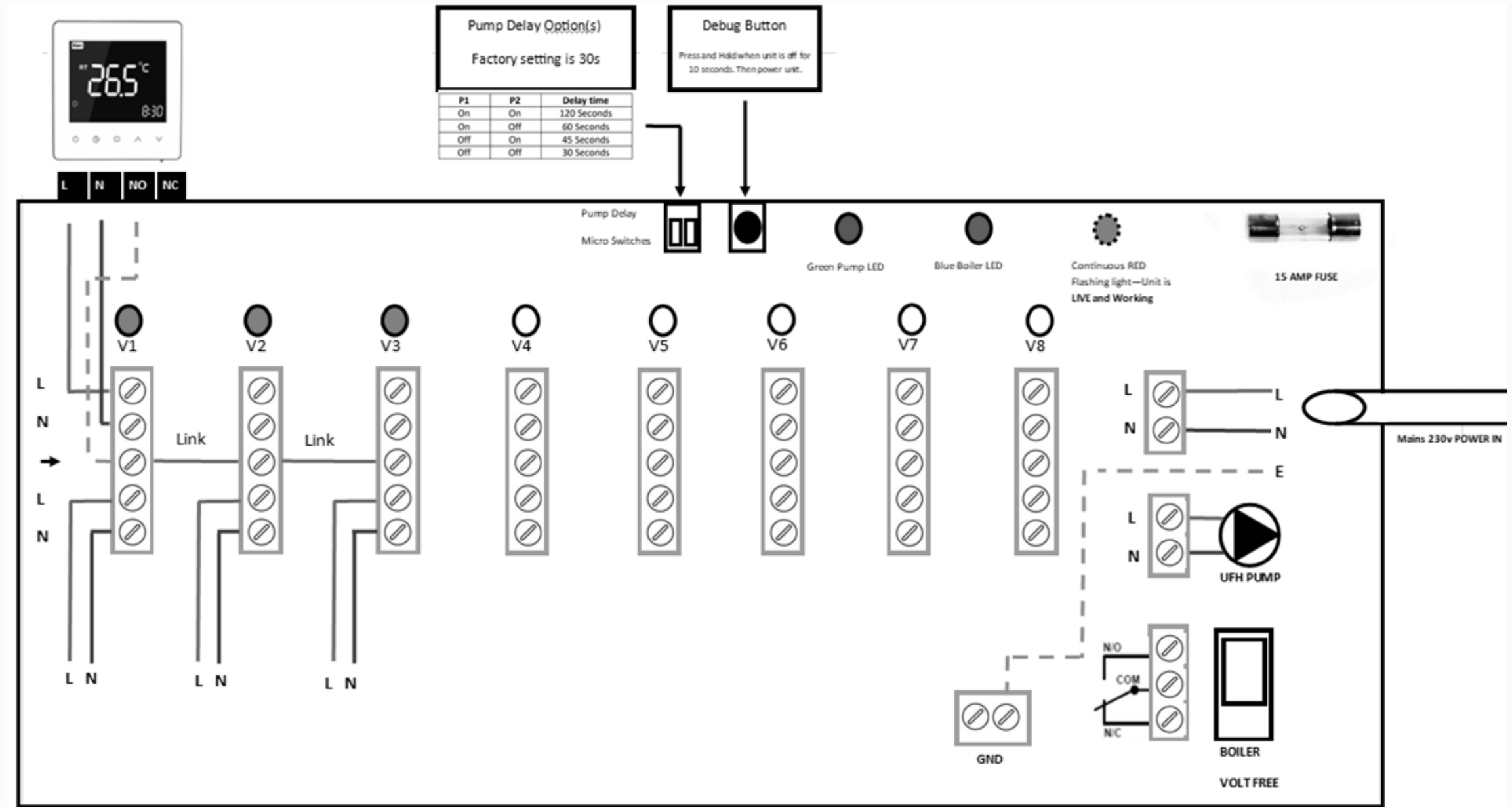

Normally closed 230V Actuators

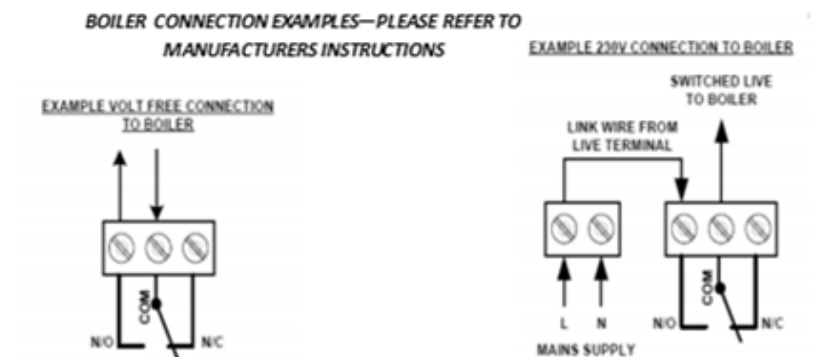



Compatible with



Download on your smart device or scan below



Scan to
Download Tuya
Smart app



Scan to
Download
Smart Life app

TIO SMART APP

Through the app, you can control the devices with voice control by integrating amazon echo or google assistant. The app arrives with an easy to use interface with elegant features. As a result, using the app is extremely straightforward.

The app also allows you to add and control a variety of devices at once. You can also let the device to automatically start or stop based on the location, time, and temperature. It also allows you to share the control of the devices amongst the family members. It also includes a real-time safety feature that will enable you to ensure the protection in case if anything went wrong.



HOW TO USE APP

How to use the Smart Life App

Start with installing the app on your device.

Open the application and register for an account.

The app will automatically detect your country code. In case it does not detect, you will require entering the code manually.











There will be a verification code sent that you will require entering for confirming the registration.

Click on the plus icon in the top right of the app to add a device. The app should automatically pair with the device. In case you see a message that says failed to add, then it means the connection is not paired. You will require pairing with the app manually. After successfully pairing with the application, you can set the name of the device. Now you will be able to control the devices from your app interface.





SMART APP FEATURES

-  Power: On/Off Red = Power ON, Blue = Power OFF
-  Mode: You can select between; Manual, ECO or Program mode
-  Manual Mode: In this setting you can change the temperature manually
-  Eco Mode: In this mode your thermostat will run at 16 °C. The temperature cannot be changed whilst in eco mode.
-  Program Mode: In this mode you can program your thermostat. Click Program mode the select program on the landing page to enter the program page.
During program mode you can set your desired time periods and temperatures for
 - (Mon-Fri + Sat + Sun) = (5+1+1)
 - 6 time periods per day.You also have the option to re-name time periods. Once you have selected your desired; times, temperatures and name press save in top left corner
-  Lock/Unlock your thermostat. Red = Locked Blue = unlocked
-  Settings: In settings you are able to;
-  **Temperature Compensation:** You can manually configure/calibrate your thermostat temperature
-  **Frost Protection:** Turn on/off frost protection
-  **Factory data reset:** This will re-set all data and programs to factory default settings
-  **Third party access** – voice control. To connect with Amazon Alexa or Google Assistance



www.tioclimatesolutions.co.uk